

Cuadernillode

INGLES

2º

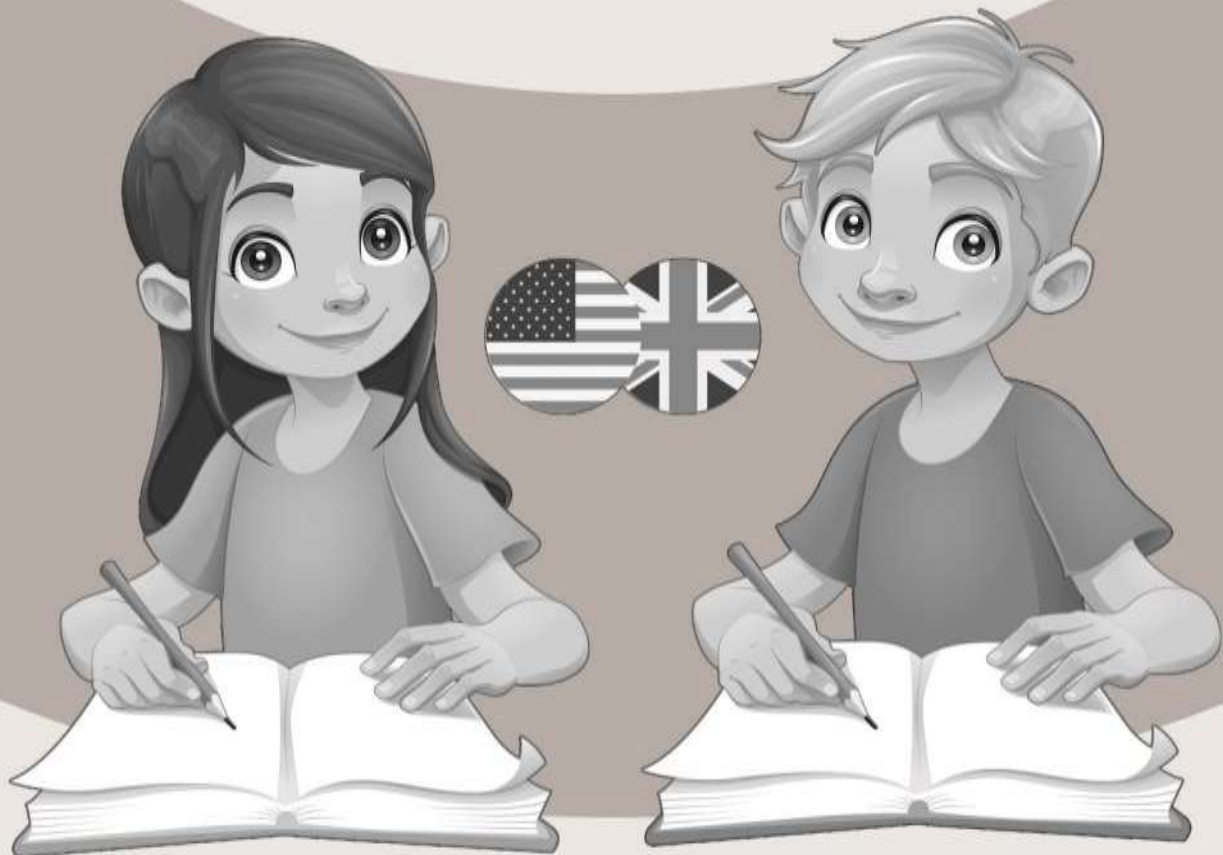

English notebook

Nombre: _____

THE ALPHABET

(di álfabet) El alfabeto

A a.
(ei)

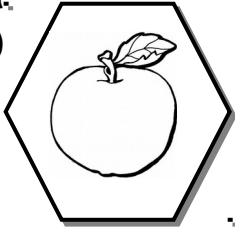

Apple

B b.
(bi)

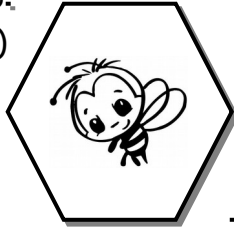

Bee

C c.
(ci)

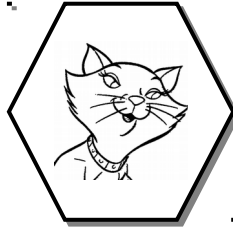

Cat

D d.
(di)

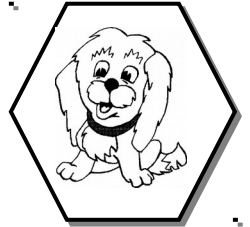

Dog

E e.
(i)

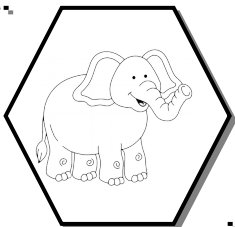

Elephant

F f.
(ef)

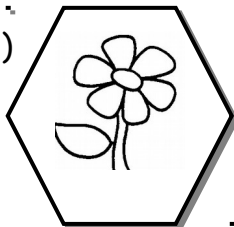

Flower

G g.
(yi)

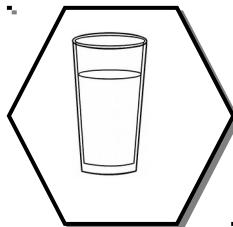

Cat

H h.
(éich)

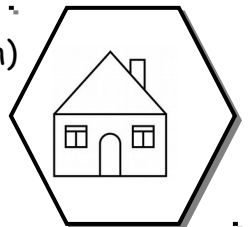

House

I i.
(ái)

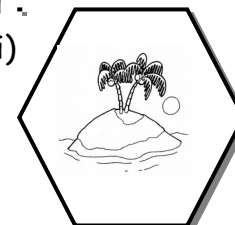

Island

J j.
(yéi)

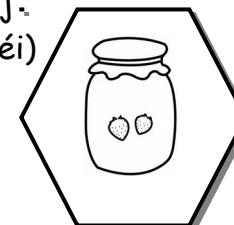

Jam

K k.
(kéi)

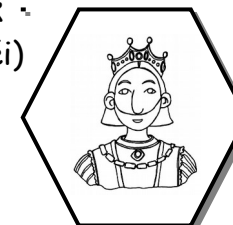

King

L l.
(el)

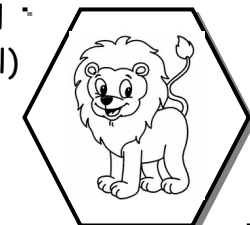

Lion

M m.
(em)

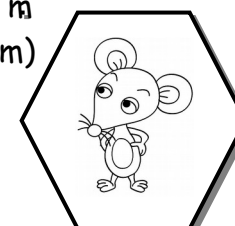

Mouse

N n.
(en)

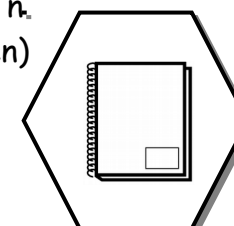

Notebook

O o.
(óu)

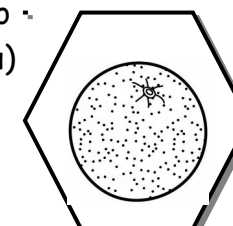

Orange

P p.
(pi)

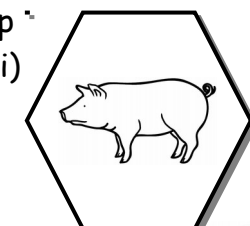

Pig

Q q -
(quiú)

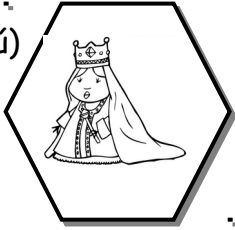

Queen

R r -
(ar)

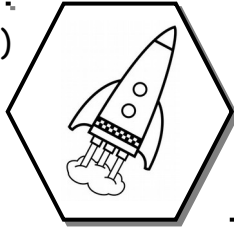

Rocket

S s -
(es)

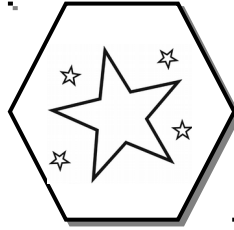

Star

T t -
(ti)

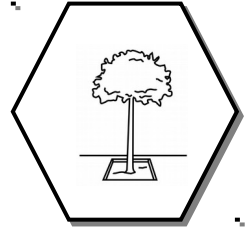

Tree

U u -
(iú)



Umbrella

V v -
(vi)

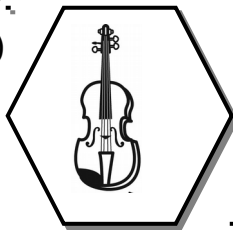

Violín

W w
(dabliú)

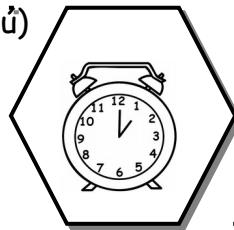

Reloj

X x -
(éxs)

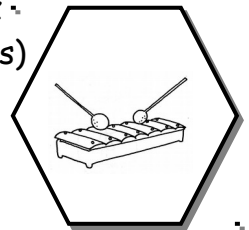

Xilophone

Y y -
(uái)

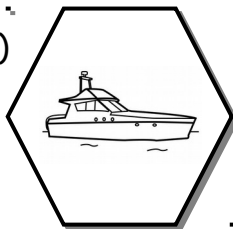

Yacht

Z z -
(ssi)



Zebra

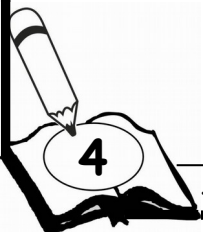

GREETINGS

(Greetings) SALUDOS

Complete the following greetings. (Completa los siguientes saludos)

Hello
Miss!



.....
Michel

Good
Morning
Mother!



Good
.....
...
Mary

Good
afternoon son!



Good
.....
...
Mother!

Good night
Peter!



Good
.....
...
doctor!

Good bye
Juan!



Good
.....
...
Teacher!



RECORDANDO

Español	Ingles	Se lee
Hola	Hello	jelou
Buenos dias	Good Morning	gud morning
Buenas tardes	Good afternoong	gud afternun
Buenas noches	Good night	gud nait
Adios	Good Bye	gud bai

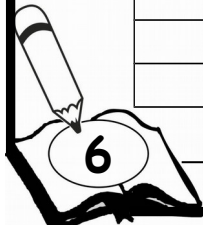

THE COLORS

(Da colors) LOS COLORES

Pronounce and then color according to color. (Pronuncia y luego colorea segun los colores)



Violet
váiolet



Yellow
iélou



Blu
Blúu



White
guáit



Green
gríin



Gris
gréi



Red
Red



Brown
bráun



Black
blák



Orange
órendch

WHAT COLORS IS THIS?

(What color is this) De qué color es...?

Color the pictures and then write the color you used. (colorea los dibujos y luego escribe el color que usaste)

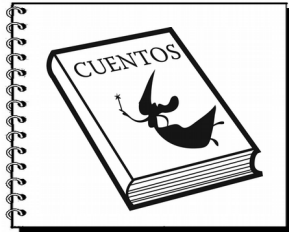

It is book

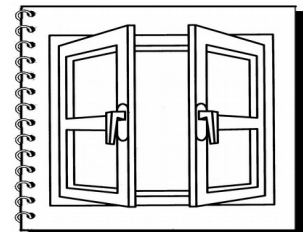
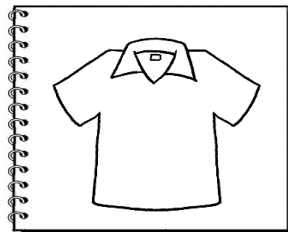
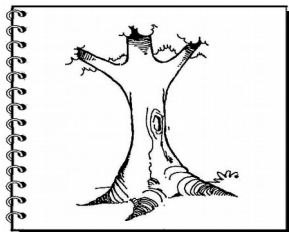
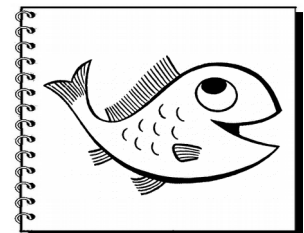
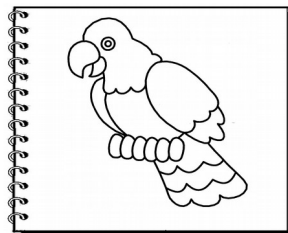
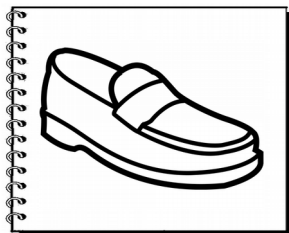
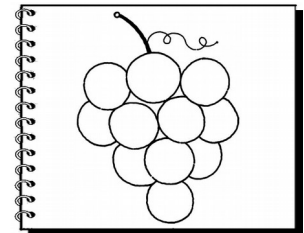
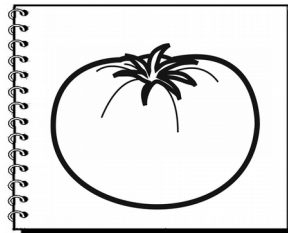
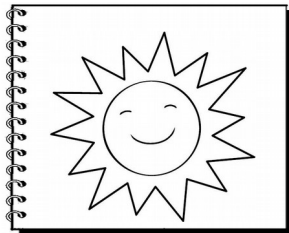
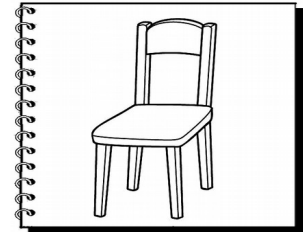
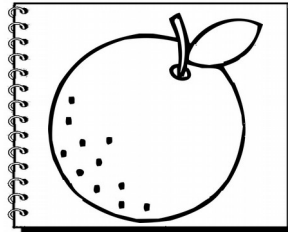

THE COLORS

(Da colors) LOS COLORES

Ask your friends. What's your favorite color?. (Pregunta a tus amigos. ¿Cuál es tu color favorito?)

Color	Count	total
orange		
red		
blue		
green		
yellow		

How many like orange ? _____ like _____

How many like red ? _____ like _____

How many like green ? _____ like _____

How many like yellow ? _____ like _____

How many like blue ? _____ like _____

Color. Use your favorite color. ((Colorea. Usa tu color favorito)

I like _____

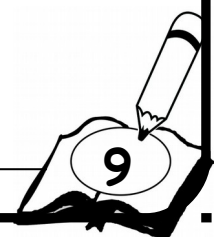
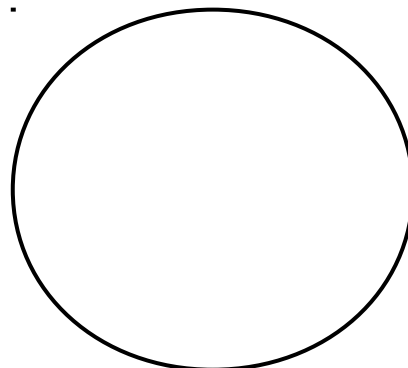

CLASSROOM OBJETES

(Clasrum obyects) OBJETOS DEL AULA

Color the objects (Colorea los objetos)

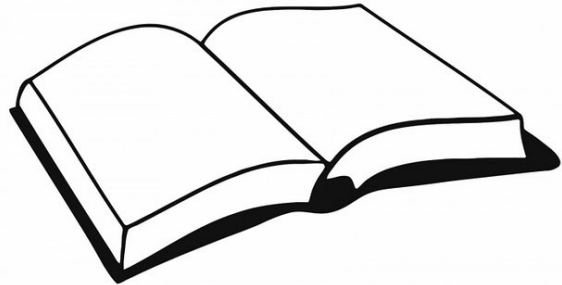

My scissors (sisors) are yellow.

My pencil (pencil) is grey

My eraser (ereiser) is red.

My notebook (notbuk) is blue

My pen (pen) is Black

My book (buk) is brown

My crayon (crayon) is green

My bagpack (bagpak) is purple

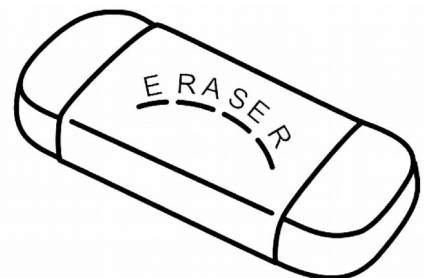
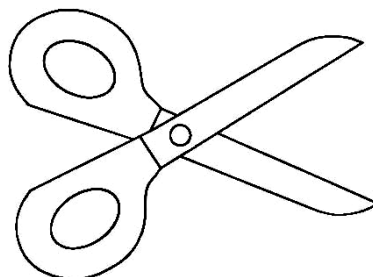
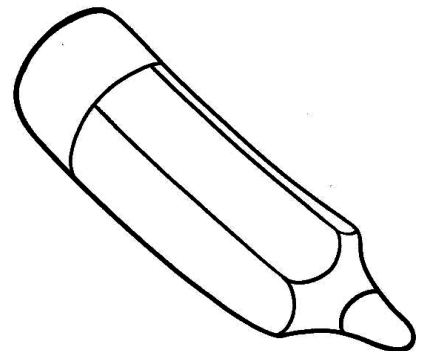
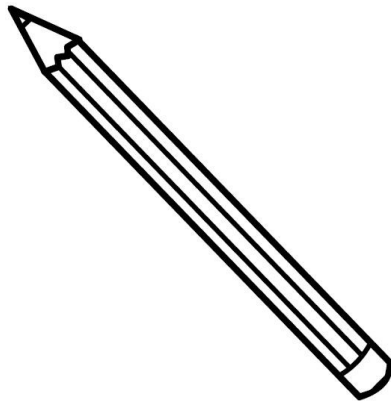
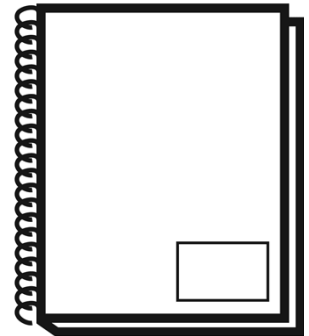

10

- Ten

Complete words with missing vowels. (Completa las palabras con las vocales que faltan)



B _ _ _ _ k

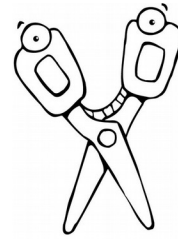

Sc _ _ ss _ _ rs

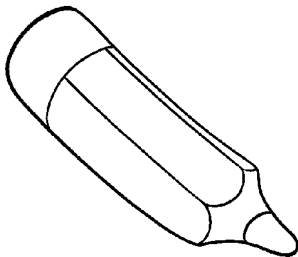

P _ _ nc _ _ l

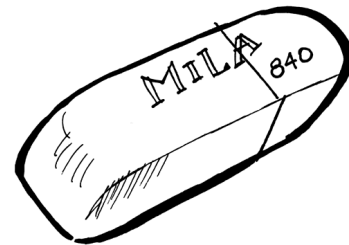

_ _ r _ _ s _ _ r

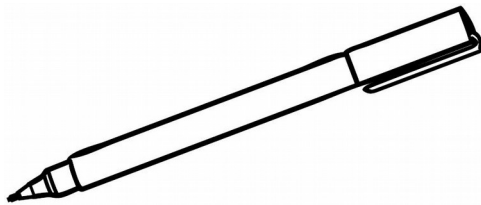

P _ _ n



Gl _ _ _ _

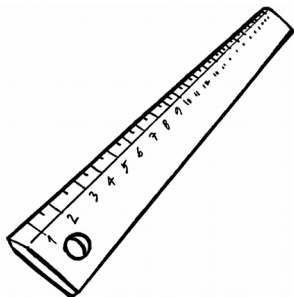

r _ _ l _ _ r



b _ _ g

Complete the following crossword. (Completa el siguiente crucigrama)

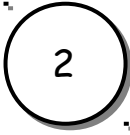
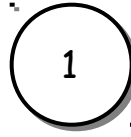
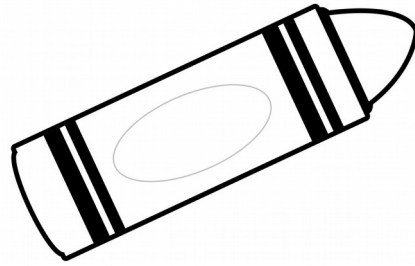

¹C
³R

²B

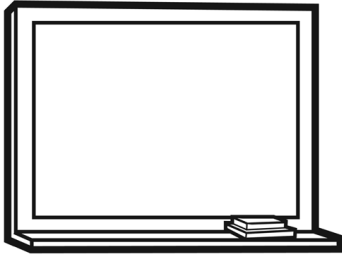

⁴N

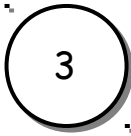
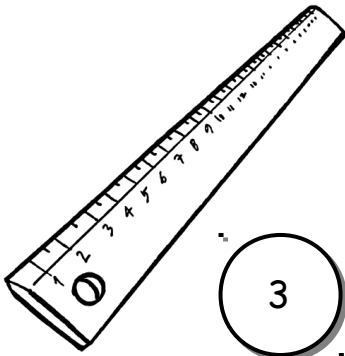

⁵S

⁶P

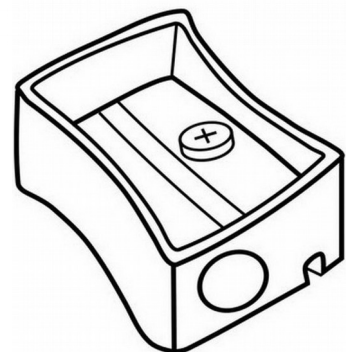
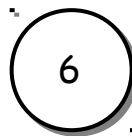
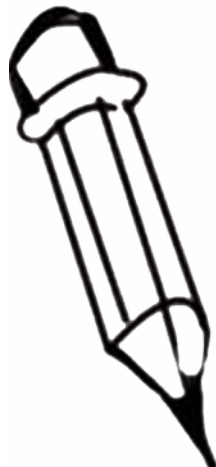
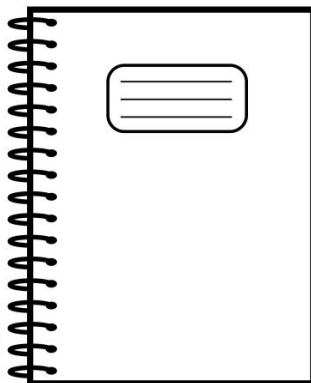
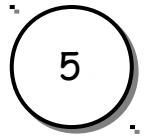

ANIMALS

(Animals) ANIMALES

VOCABULARIO

ESPAÑOL	INGLES	SE LEE
Araña	Spider	spáida
Ballena	Whale	uéil
Caballo	Horse	hors
Cerdo	Pig	pig
Ciervo	Deer	díer
Conejo	Rabbit	rábit
Delfín	Dolphin	dólfín
Elefante	Elephant	élefant
Foca	Seal	si:ol
Gallina	Hen	hen
Gallo	Cock	coc
Gato	Cat	cat
Gorila	Gorilla	gorila
Hámster	Hamster	hámsta
Hormiga	Ant	ant
Jirafa	Giraffe	giráf
León	Lion	láion
Lobo	Wolf	uof
Loro	Parrot	párot
Mariposa	Butterfly	báterflai
Mono	Monkey	mánki
Mosca	Fly	flái
Murciélago	Bat	bat
Oso	Bear	bee
Pájaro	Bird	berd

Write the correct answer. (Escribe la respuesta correcta)

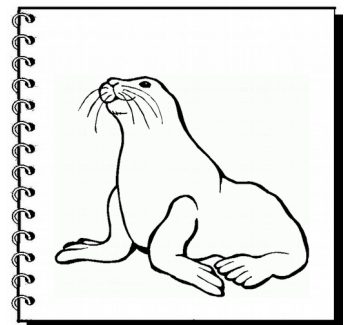
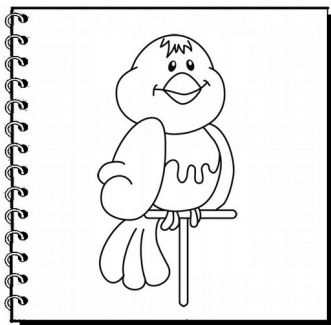
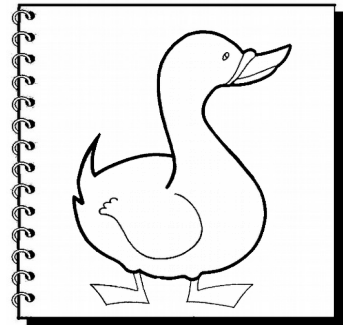
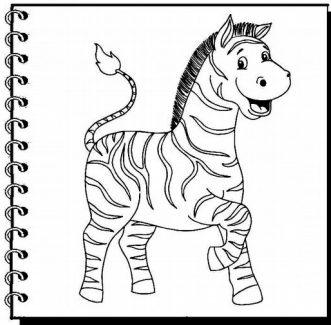
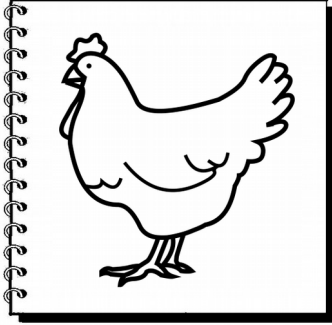

order these words (Ordena estas palabras)



GDO

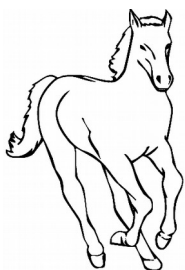

RESOH

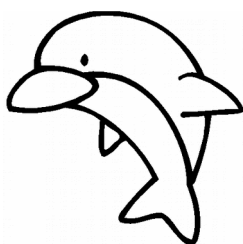

LNDPOHI

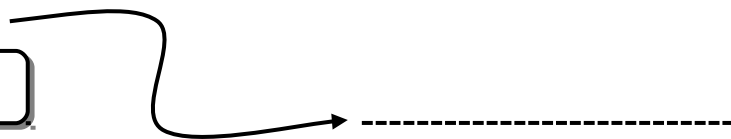

EGAEL

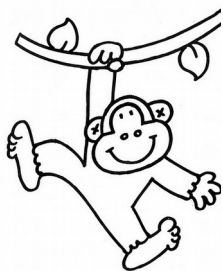

NYMKOE



DAYS OF THE WEEK

(Deis of da wik) DÍAS DE LA SEMANA

Complete the words with missing vowels. (Completa las palabras con las vocales que faltan)

M _ _ nd _ _ y

T _ _ _ sd _ _ y

W _ _ dn _ _ sd _ _ y

Th _ _ rsd _ _ y

Fr _ _ d _ _ y

S _ _ t _ _ rd _ _ y



S _ _ nd _ _ y

MONTHS OF THE YEAR

(monfs of da yíar) MESES DEL AÑO

Review the words. Pronounce the months of the year. (Repasa las palabras. Pronuncia los meses del año)

january

Yanuari (Enero)

february

februari (Febrero)

march

march (Marzo)

april

eipril (Abril)

may

mei (Mayo)

june

jun (Junio)

july

yulai (Julio)

august

ogost (Agosto)

september

September (Setiembre)

october

october (Octubre)

november

november (Noviembre)

december

december (Diciembre)

MY FAMILY

(mai fámili) MI FAMILIA

Español	Ingles	Se lee
Abuela	Grandmother	grandmada
Abuelo	Grandfather	grandfada
Abuelos	Grandparents	grandperents
Esposa	Wife	uáif
Esposo	Husband	hásband
Hermana	Sister	sista
Hermano	Brother	brade
Hija	Daughter	dóta
Hijo	Son	san

Write the names in the appropriate place. (Escribe los nombres en el lugar correspondiente)

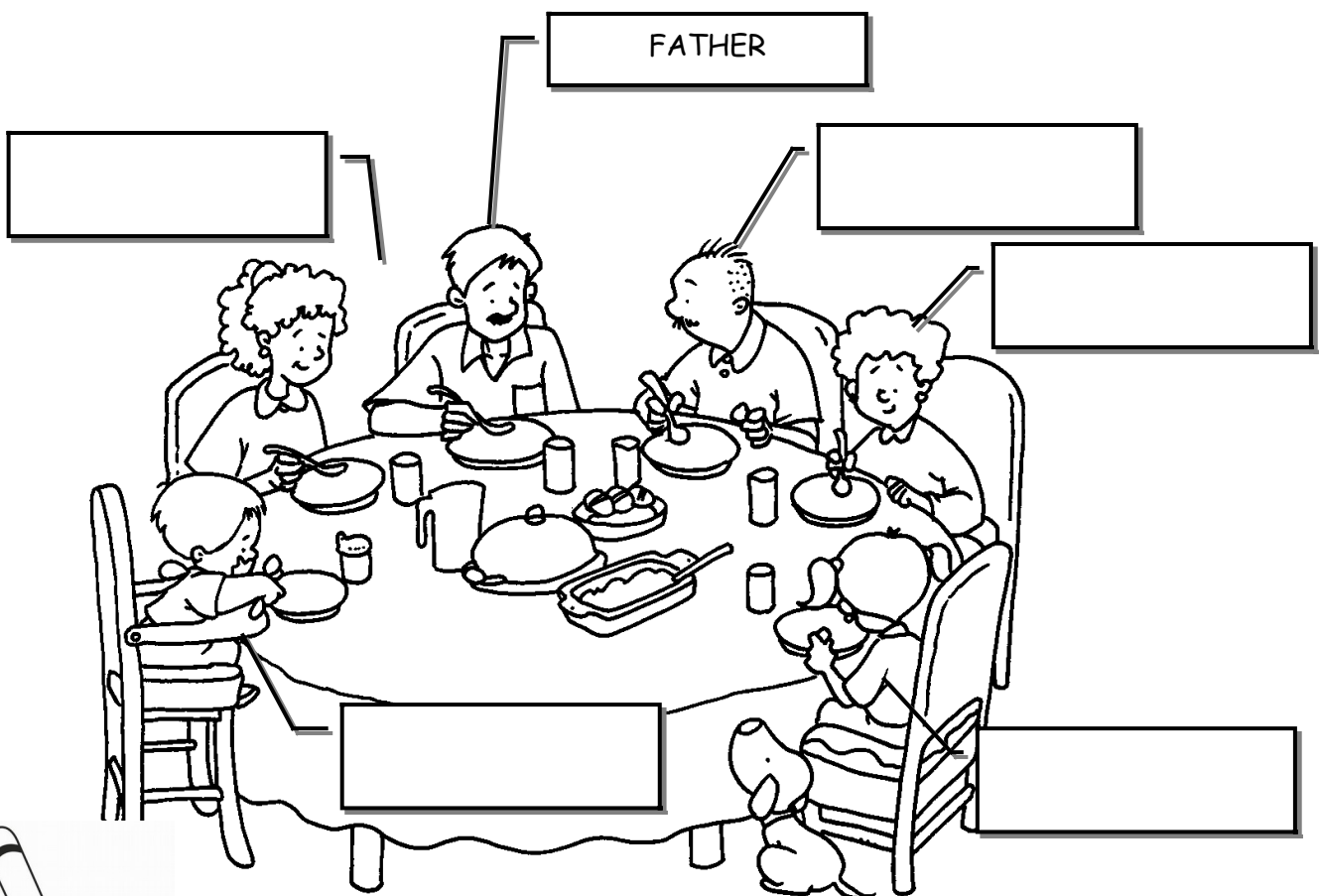

JOHN'S FAMILY

LA FAMILIA DE JUAN

The crossword puzzle grid consists of the following words and clues:

- 1** (Down): **G** (Grandmother)
- 2** (Down): **J** (Juan)
- 3** (Across): **G** (Grandfather)
- 4** (Across): **F** (Father)
- 4** (Across): **M** (Mother)
- 5** (Across): (Mother)
- 4** (Across): (Young boy)

MY FAMILY ALBUM

MI ALBÚM FAMILIAR

Paste photos. (Pega fotos)

Mom

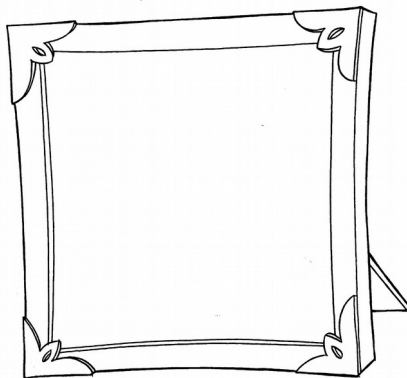

Aunt

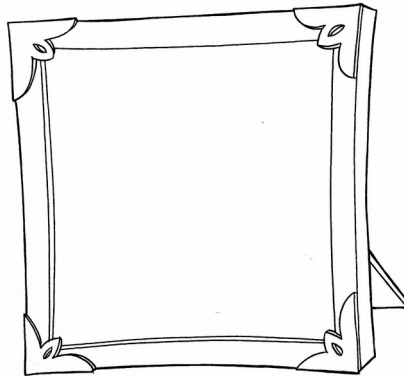

Mom

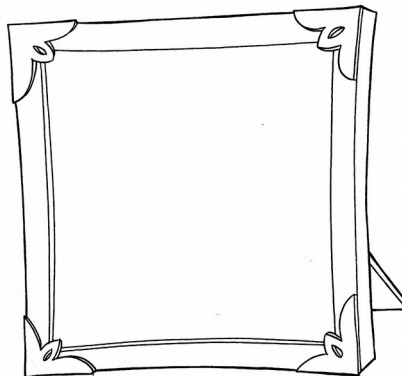

Brother

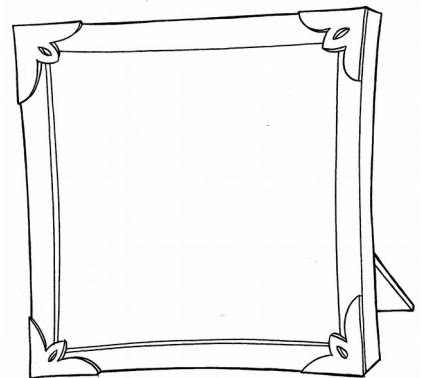

Uncle

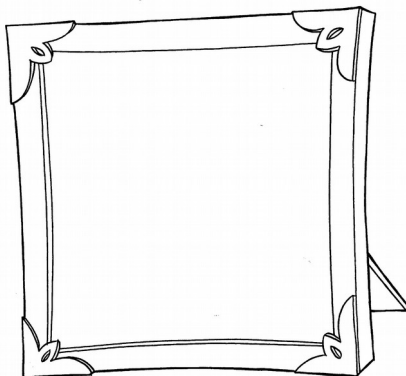

Me

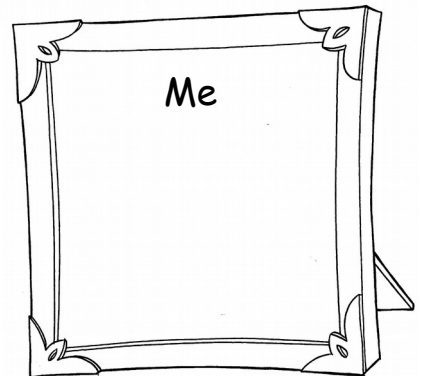

Sister

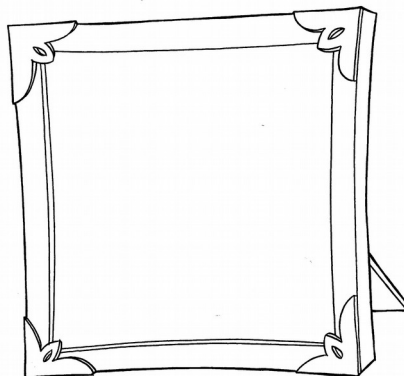

MEANS OF TRANSPORTATION

(míns of transporteishon) MEDIOS DE TRANSPORTE

VOCABULARY

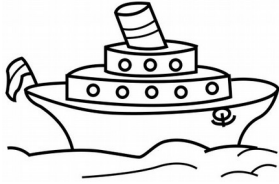

SHIP (**ship**) barco

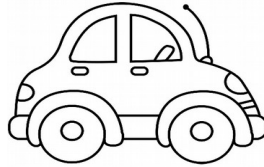

CAR (**kar**) auto

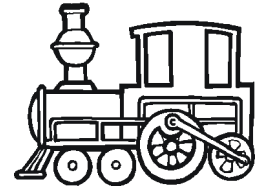

TRAIN (**trein**) tren

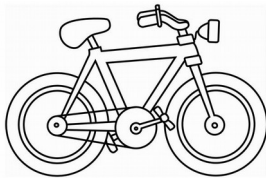

BIKE (**baik**) bicicleta

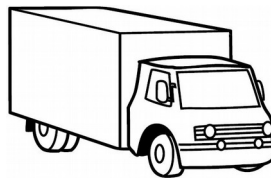

TRUCK (**trak**)
Camión

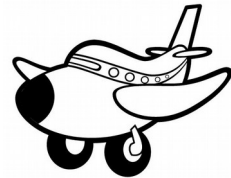

PLANE (**plein**) Avión



BUS (**bas**) ómnibus

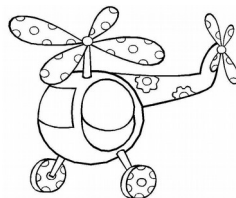

HELICOPTER (**jelicapter**)
Helicoptro

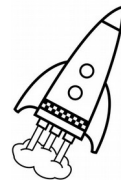

ROCKET (**róket**)
Cohete



taxi cab (**táxi cáb**)
Taxi

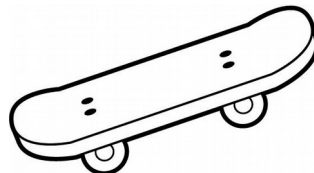

scooter (**skúter**)
Helicoptro

ROCKET (**róket**)
Cohete

Complete the following crossword. (Completa el siguiente crucigrama)

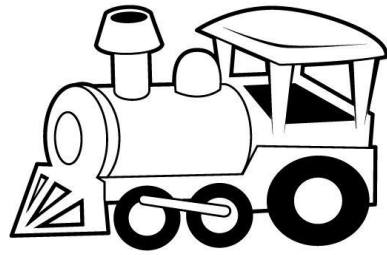

1

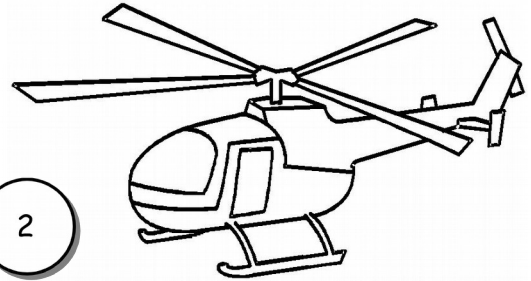

2



3



4

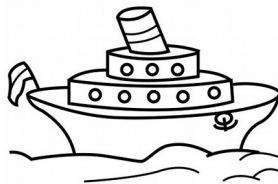

5

6

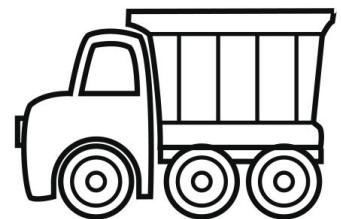
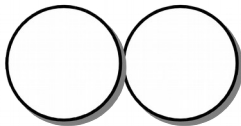

MEANS OF TRANSPORTATION

(míns of transporteishon) MEDIOS DE TRANSPORTE

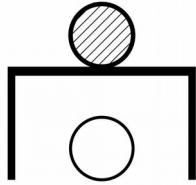

On (Encima de...)

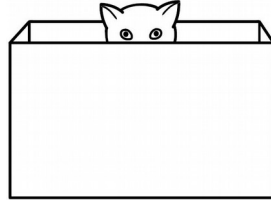

In (Dentro de...)

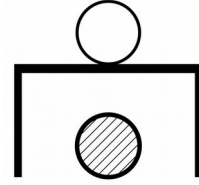

Under (Debajo de...)

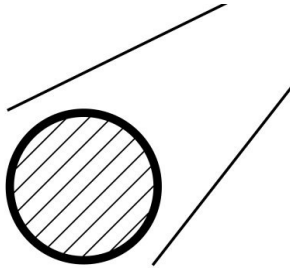

Near (Cerca de..)



Between
(en medio de...)

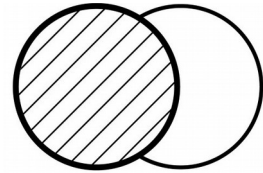

In front of
(en frente de...)

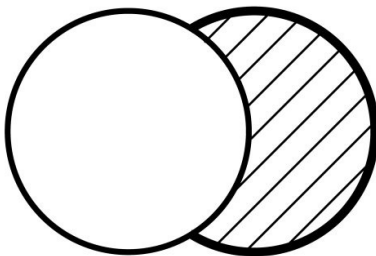

Behind
(detrás de...)



Opposite
(en frente de...)

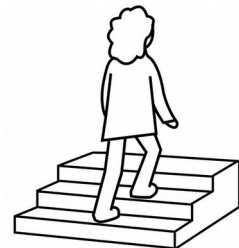

Up
(hacia arriba)

Write in the box the preposition that describes the picture.
Escribe en el recuadro la preposicion que describe el dibujo.

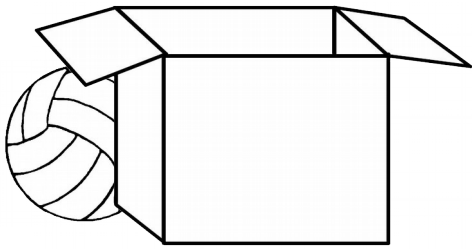

IN

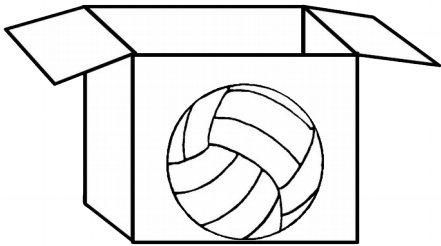

BETWEEN

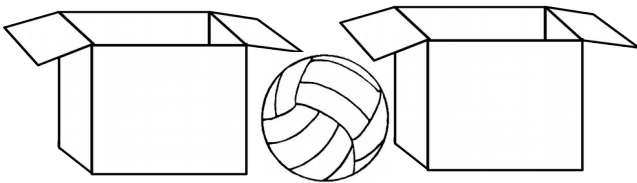

UNDER

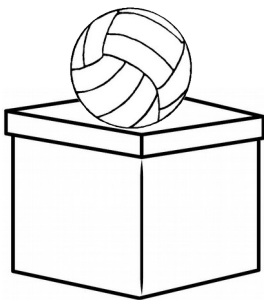

BEHIND

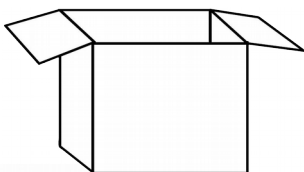

ON



NUMBERS

(numbers) NÚMEROS

VOCABULARY

Español	Ingles	Se lee	Español	Ingles	Se lee
1	One	uán	16	Sixteen	sixtiin
2	Two	tú	17	Seventeen	sevntiin
3	Three	zrii	18	Eighteen	eitiin
4	Four	foa	19	Nineteen	naintiin
5	Five	faiv	20	Twenty	Tuenti
6	Six	six	21	Twenty one	tuénti uán
7	Seven	sevn	30	Thirty	zérti
8	Eight	éit	32	Thirty two	zérti tú
9	Nine	náin	40	Forty	fórti
10	Ten	ten	43	Forty three	fórti zrii
11	Eleven	ilevn	50	Fifty	fífti
12	Twelve	tuelv	54	Fifty four	fífti foa
13	Thirteen	zertín	60	Sixty	sixti
14	Fourteen	fortín	66	Sixty six	sixti six
15	Fifteen	fiftiin	70	Seventy	sevnti



MIXING NUMBERS

Complete and color. (Completa y colorea)

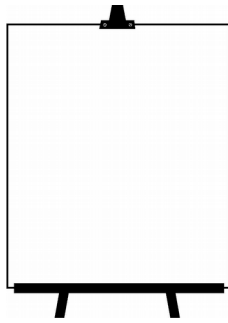

three

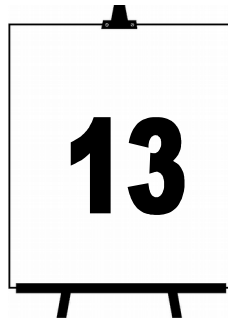

_____ Teen

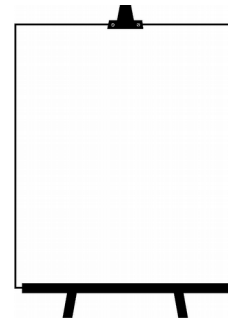

Fifty

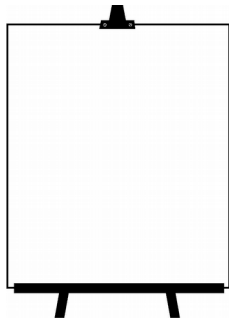

Two

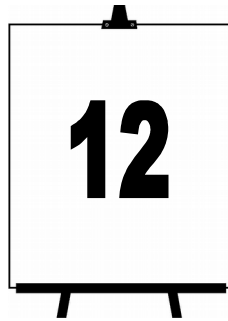

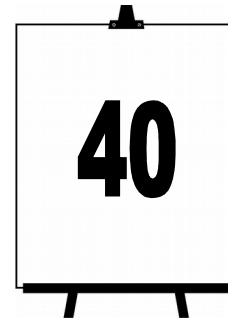

For _____

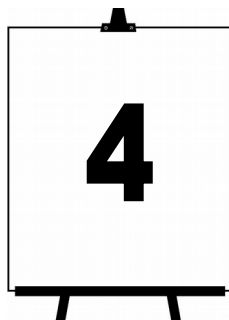

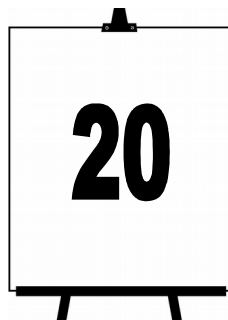

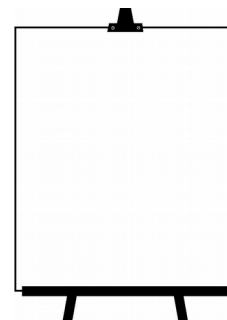

six

HOW OLD ARE YOU?

(jau ould ar iu) ¿CUÁNTOS AÑOS TIENES?

Look at the picture and read what they are saying. Then write who they are.
(Mira la foto y lee lo que están diciendo. Luego de escribe quienes son)



¿Who? (Quién)

- a) They are ten years old. _____
- b) He is seven. _____
- c) She is eight. _____
- d) He is nine years old. _____

Answer these questions: (responde a estas preguntas)

- a) Are you ten years old? _____
- b) How old are you? _____
- c) How old is your mother? _____

FOOD

(fud) ALIMENTOS

VOCABULARY

Español	Ingles	Se lee
Nabo	Turnip	Turnip
Sandía	Watermelon	uótermélon
Uvas	Grapes	gréips
Zarzamora	Blackberry	/blákbéri
Pera	Pear	péar
Piña	Pineapple	páinápel
Plátano	Banana	benána
Papaya	Pawpaw	pópou
Naranja	Orange	órendch
Mandarina	Tangerine	tányarin
Mango	Mango	mángou
Manzana	Apple	ápel
Café	Coffee	cofi
Leche	Milk	milk
Queso	cheese	chís
Pepinillo	Cucumber	cúcumber
Tomate	Tomato	Tomeito

Español	Ingles	Se lee
Huevo	Egg	eg
Arroz	Rice	ráis
Té	Tea	tí
Pan	Bread	bred
Azúcar	Sugar	shugar
mantequilla	Butter	bater
Jamón	Ham	jam
Plátano	Banana	banana
Sandia	Watermelon	watermélon
Cebolla	Onion	ónion
Zanahoria	Carrot	carrot
Apio	Celery	céleri
Limón	Lemon	lémon
Lechuga	Lettuce	letús
Papa	Potato	Poteito
Ají	Chilli	Chíli
Espinaca	Spinach	spinak

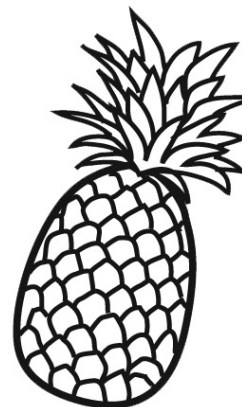
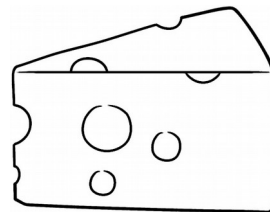
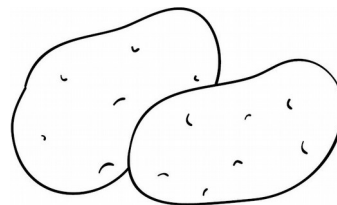
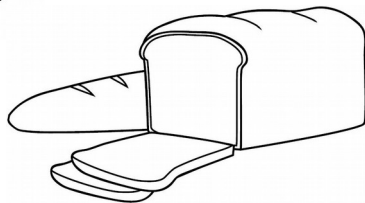
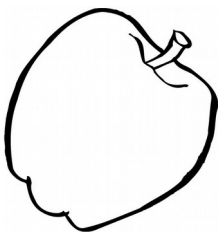

Look at the pictures and fill in the gaps. (Mira la imagen y llena los espacios vacíos)

1. I drink

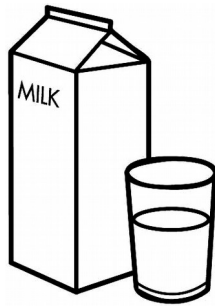

_____.

2. I go to the market and I buy

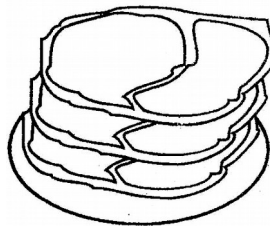

_____.

3. Please, pass me



_____.

4. There're some

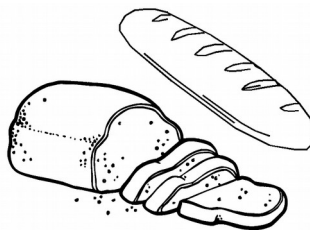

_____.

5. There are some



_____ in the bowl.

I have for breakfast

Tengo para desayunar

Complete the following crossword. (Completa el siguiente crucigrama)

1

2

3

4

5

I use for breakfast

Uso para desayunar

Seeks the following words in the puzzle.
Busca las siguientes palabras en la sopa de letras.

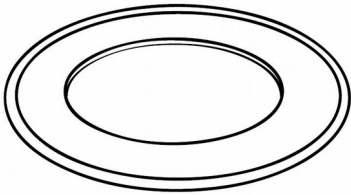

plate

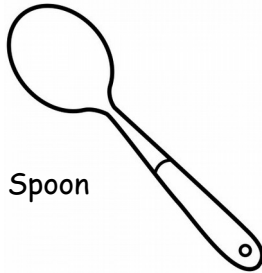

Spoon

Fork

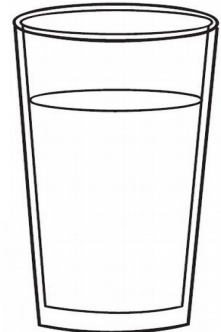

glass

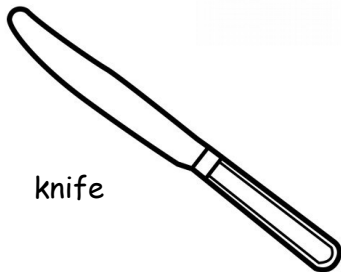

knife



ARTICLES: A-AN-THE

A (éi / e) - un, una. (se usa cuando la palabra siguiente es una consonante)

AN (an) - un, una. (se usa cuando la palabra siguiente comienza con vocal o con consonantes mudas)

THE (de / di) - el, la, lo, los, las. (Se utiliza delante de sustantivos para especificar la persona, animal o cosa a la que nos referimos. Puede acompañar al nombre en singular o en plural.

Example:



the girl

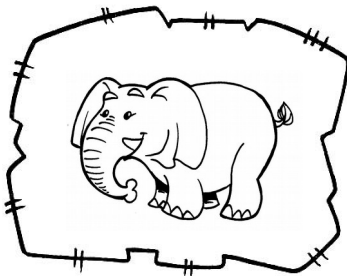

an elephant

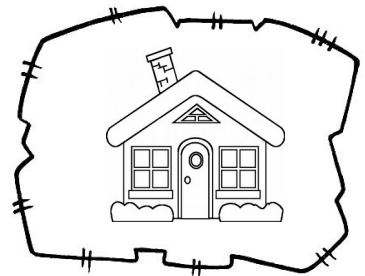

a house

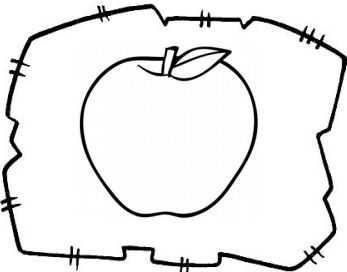

the apple

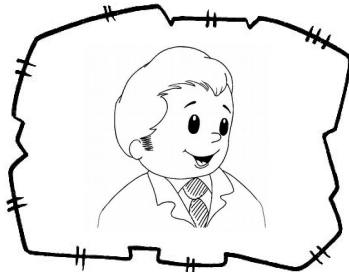

a man

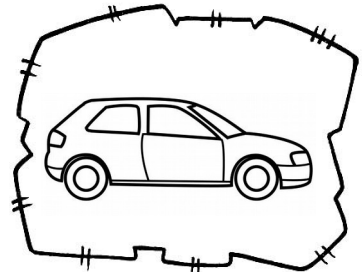

the car



An doctor

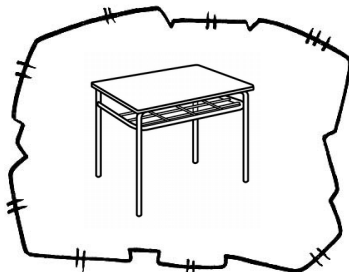

a table

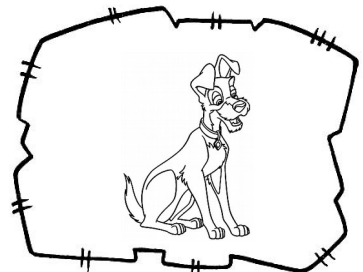

a dog

Match each picture with its corresponding article.
Une cada dibujo con su articulo correspondiente.

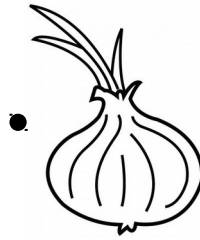
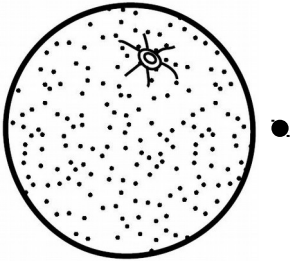

a

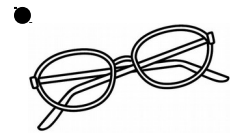
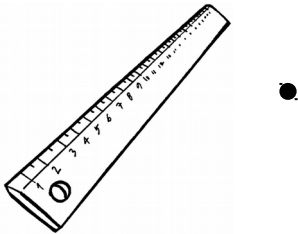

an

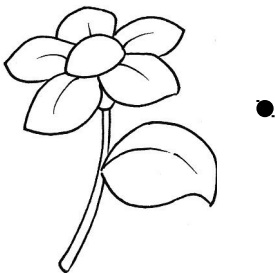

the

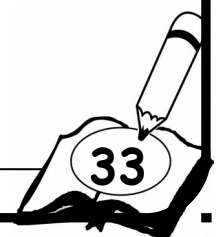
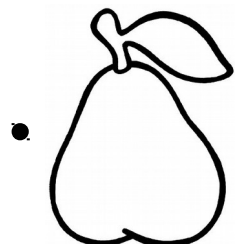
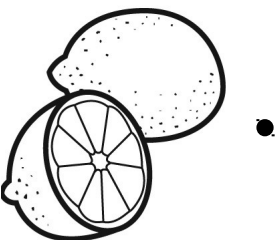

CLOTHES

(clozs) PRENDAS DE VESTIR

VOCABULARY

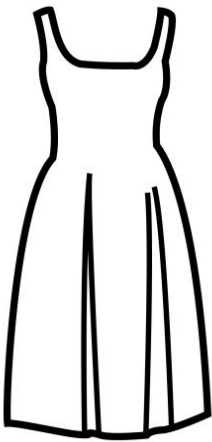

ESPAÑOL	INGLES	SE LEE
camisa	shirt	(shert)
Zapatos	shoes	(shus)
Pantalón corto	shorts	(shorts)
Bufanda	scarf	(skárf)
Zapatillas	sneakers	(sníkers)
Medias	socks	(sóks)
corbata	tie	(tái)
Pantalones	pants	(pants)
Abrigo	coat	(kóut)
blusa	blouse	(bláus)
vestido	dress	(dres)
falda	skirt	(skért)

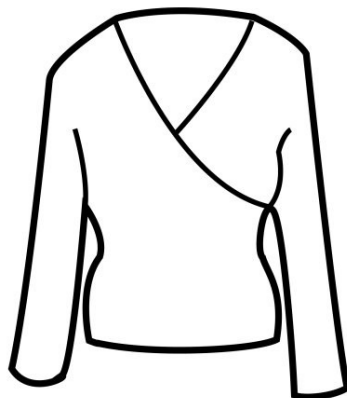
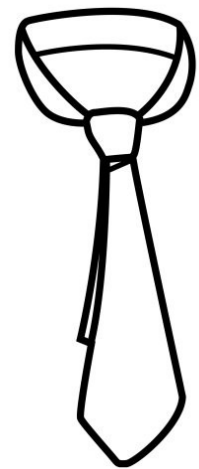



Are these Bart's sport shoes?

_____ / _____ / _____

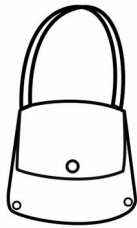

Is this Amy's bag?

_____ / _____ / _____



Is this Jessie's shirt?

_____ / _____ / _____



Are these Dean's sweater?

_____ / _____ / _____

Answer the following question. (Responde la siguiente pregunta)

What is it?



It is a shoes.



It is a drees.











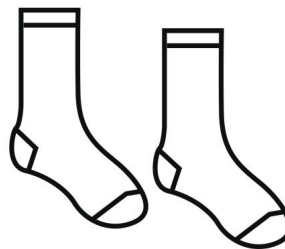



ADJECTIVES

(adjectives) ADJETIVOS

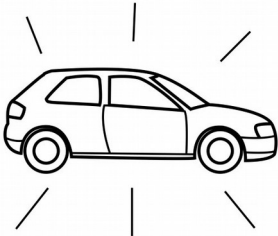

New (**niu**)
Nuevo (a)

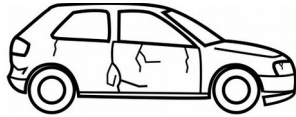

Old (**ould**)
Viejo (a)

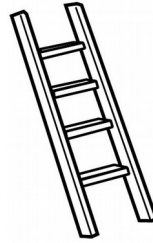

Big (**big**)
Grande



Small (**smol**)
Pequeño



Fat (**fat**)
Gordo (a)

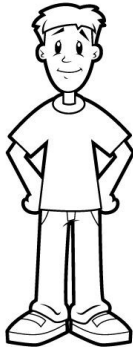

Thin (**zin**)
Flaco



Short (**short**)
Bajo (a)



Tall (**tol**)
Alto (a)



Happy (**jápi**)
Feliz

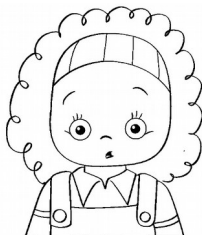

Scared (**squer**)
Asustado



Angry (**éngri**)
Enojado



Sad (**sád**)
Triste

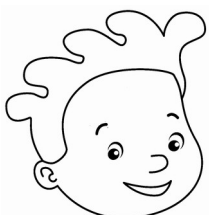

Pretty (**priti**)
Bonito (a)



Ugly (**ágil**)
Feo

Complete the following sentences. (Completa las siguientes oraciones)

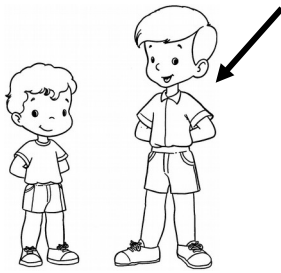

the _____ boy.



a _____ child.



a _____ book.



A _____ man.

Look at the pictures and circle the correct answer. (mira las figuras y encierra en un círculo la respuesta correcta)

1

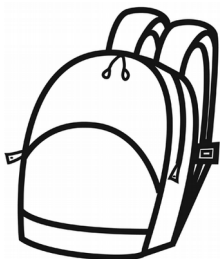

Small bag / big bag

2

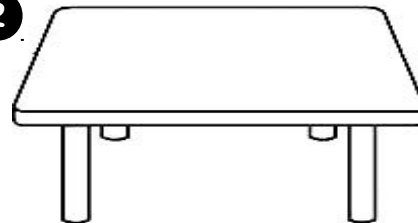

big table / long table.

3

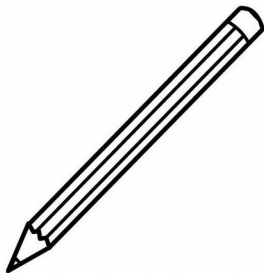

Long pencil / short pencil.

4

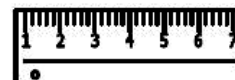

Short ruler / long ruler.



Write. (Escribe)



His name is Peter

Her name is Mary.

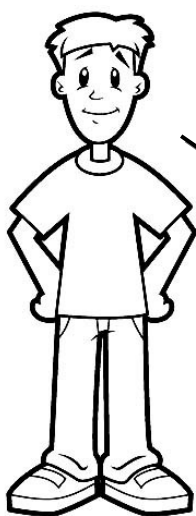

His name is Carlos.

He's _____



My name's Susy.

I'm _____

I'm _____



ACTIONS

(acshons) ACCIONES



VOCABULARY

ESPAÑOL	INGLES	SE LEE
escribir	Write	(ráit)
Dormir	Sleep	(slip)
Cantar	Sing	(sing)
Leer	Read	(rid)
Cocinar	Cook	(cuk)
Comer	Eat	(it)
Tomar	Drink	(drink)
Dibujar	Draw	(dro)
Lavar	Wash	(uásh)
Pintar	Paint	(paint)
Saltar	Jump	(yamp)
Patinar	Skate	(squéit)
Bailar	Dance	(deáns)
Correr	Run	(run)
Llorar	Cry	(cki)

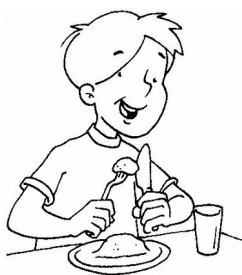

Make sentences using presente continuons (ing)
Hacer oraciones haciendo uso del Ing.



Write

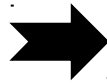

I´m writing



Mourn

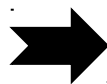

Run

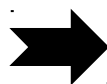

Play



Write sentences using verbs. (Escribe oraciones haciendo uso de los verbos)



She is Drawing

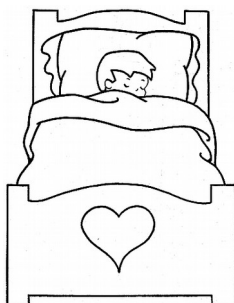

What is he/ she doing?

¿Qué hace él o ella?

Write. (Escribe)



He's _____



He's _____



He's _____



He's _____

MY BODY

(mai badi) MI CUERPO

VOCABULARY

Español	Ingles	Se lee
Boca	Mouth	máuz
Brazo	Arm	áarm
Cabeza	Head	héd
Cara	Face	féis
Codo	Elbow	élbou
Corazón	Heart	hárt
Dedos	Fingers	fínguers
Diente	Tooth	túuz
Dientes	Teeth	tíiz
Espalda	Back	bák
Cabello	Hair	héer
Caderas	Hips	hips
Cejas	Eyebrows	áibráus
Pecho	Chest	chést

Español	Ingles	Se lee
Labios	Lips	lips
Mano	Hand	hánd
Nariz	Nose	nous
Ojos	Eyes	áis
Orejas	Ears	íars
Pie	Foot	fút
Pierna	Leg	leg
Pies	Feet	fíit
Rodilla	Knee	níi
Uñas	Nails	néils
Cuello	Neck	nék
Frente	Forehead	fórid
Hombro	Shoulder	shóulder
Pestañas	Eyelashes	áiláshis

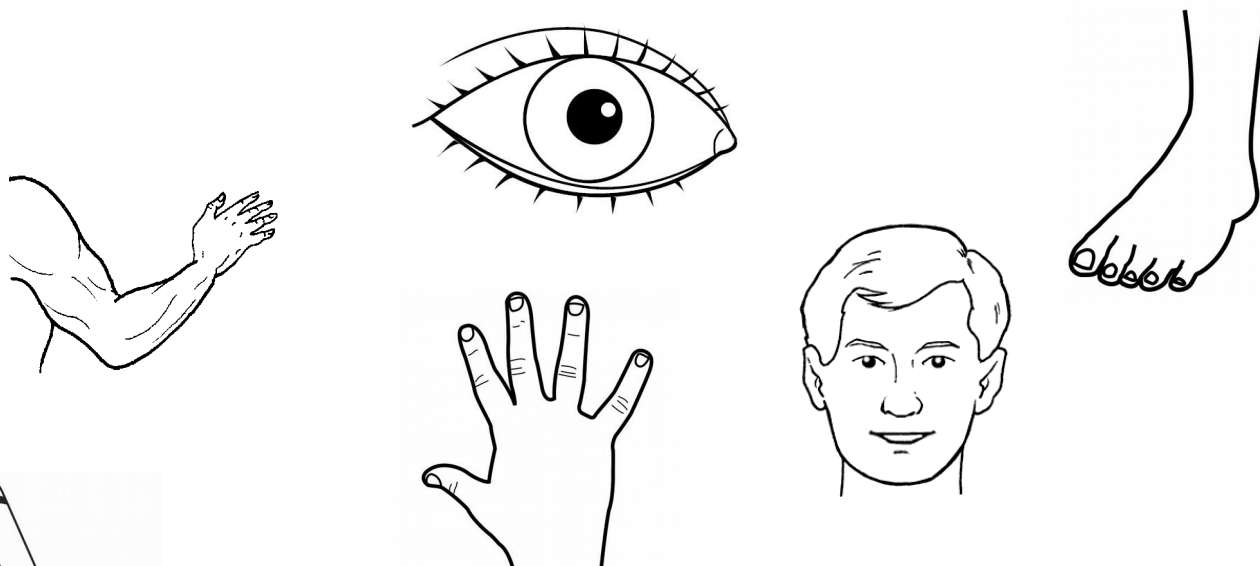

Color the pictures and write on the dotted line their names in English
Colorea los dibujos y escribe sobre la línea de puntos sus nombres en inglés



Blank writing lines for the word 'Foot'.

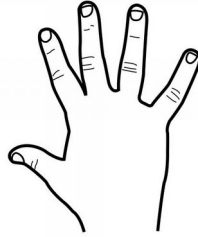

Blank writing lines for the word 'Hand'.

Hips

Back

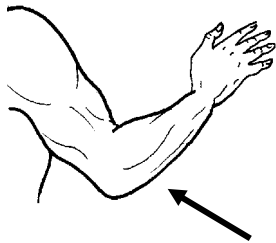

Blank writing lines for the word 'Elbow'.

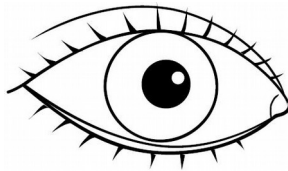

Blank writing lines for the word 'Eye'.

Foot

Face

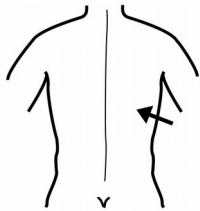

Blank writing lines for the word 'Shoulders'.

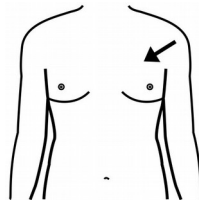

Blank writing lines for the word 'Shoulder'.

Hand

Eyes



Blank writing lines for the word 'Face'.

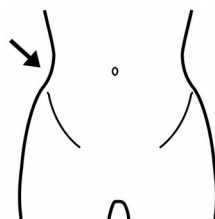

Blank writing lines for the word 'Arm'.

Chest

Arm



Complete the following crossword. (Completa el siguiente crucigrama)

A crossword puzzle grid consisting of 11 empty circles. The clues are as follows:

- Horizontal clue 1: Mouth (4 letters)
- Vertical clue 1: Hand (5 letters)
- Horizontal clue 2: Head (4 letters)
- Vertical clue 2: Ear (5 letters)
- Vertical clue 3: Leg (5 letters)
- Horizontal clue 3: Heart (4 letters)

A cartoon boy is standing on the right side of the puzzle.

MY FACE

(mai feis) MI CARA

**Full face with the missing parts. Write the missing vowels in words.
Completa la cara con las partes que faltan. Escribe las vocales que faltan en las palabras.**

___ y ___ br ___ ws

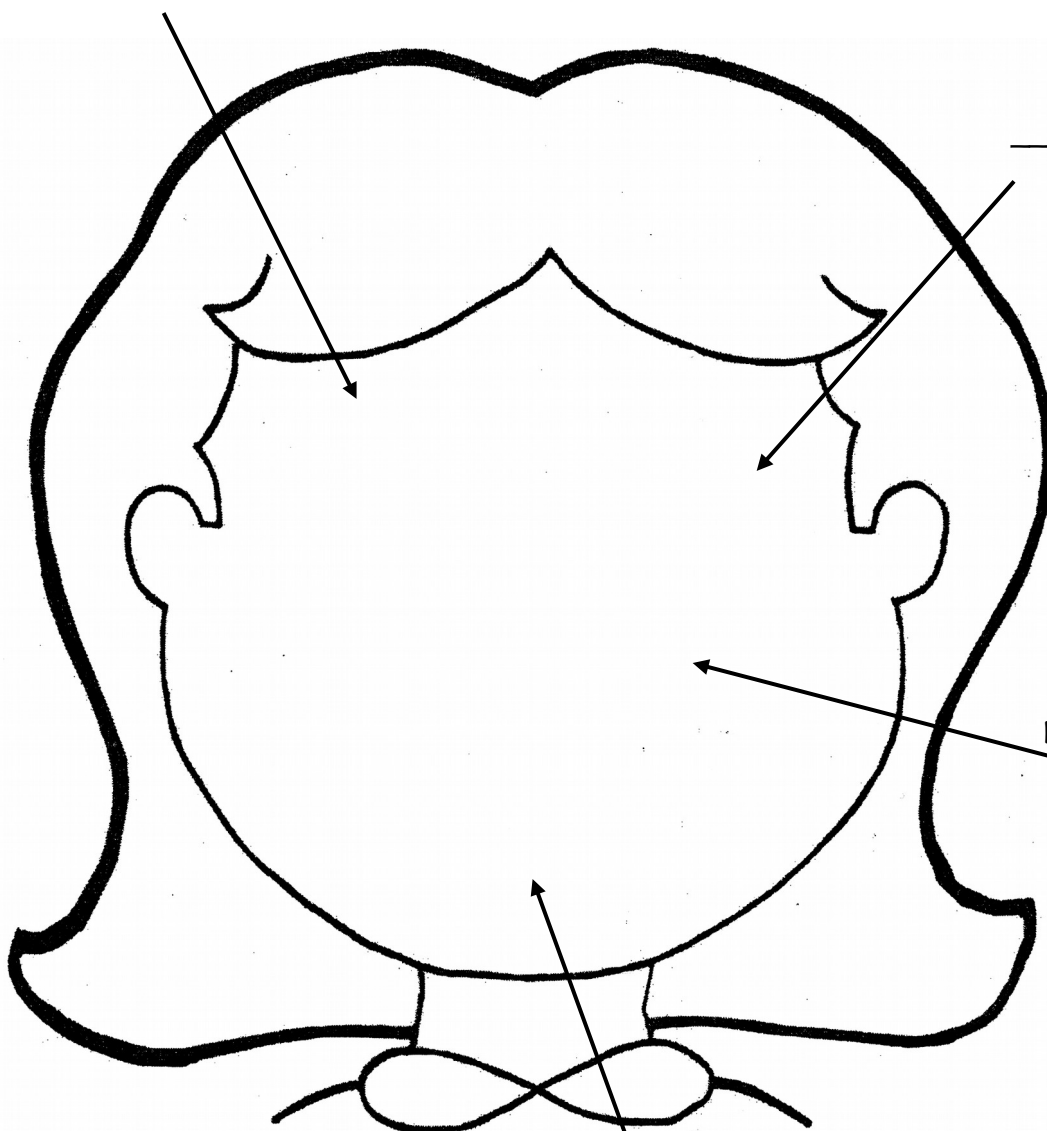

___ y ___

N ___ s ___

M ___ th



BOYS AND GIRLS

(boi an grl) LOS NIÑOS Y LAS NIÑAS

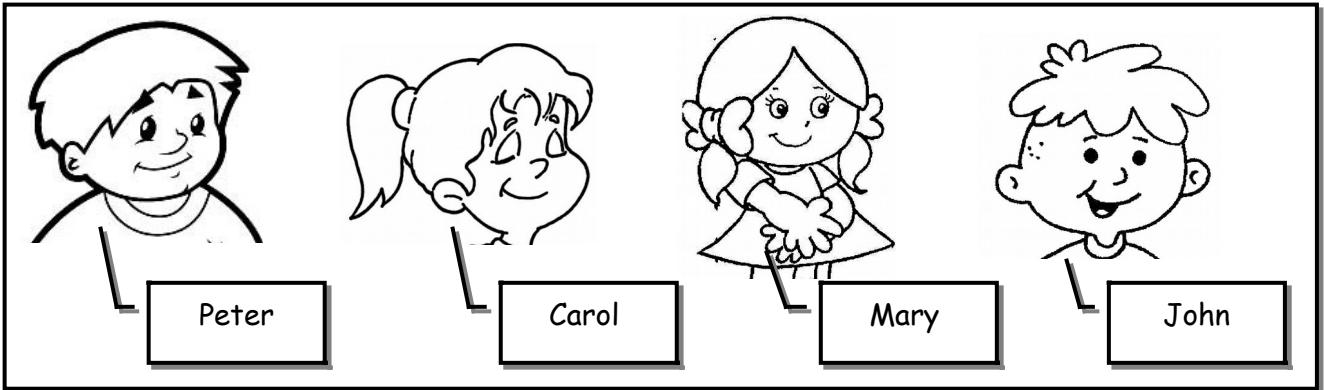

Write. (Escribe)

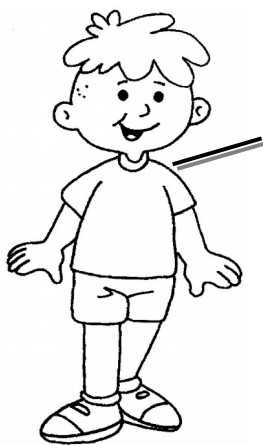

This is _____
He is a _____

This is _____
She is a _____



This is _____
She is a _____

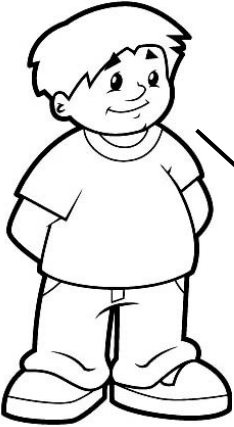

This is _____
He is a _____

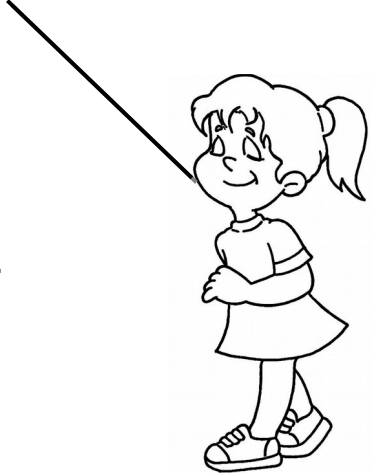

VERB TO BE

(Verb tubi) VERBO "SER O ESTAR"

El verbo **to be** significa ser o estar y en inglés se escribe am - is - are.

S I N G U L A R	I am - Yo soy - Yo estoy	P L U R A L	we are - nosotros somos - nosotros estamos
	you are - Tú eres / tú estás		you are - ustedes son - ustedes están
	he is - Él es - Él está		
	she is - Ella es - Ella está		
	it is - Eso es - Eso está		they are - ellos (as) son - ellos (as) están



I **am** not tired.

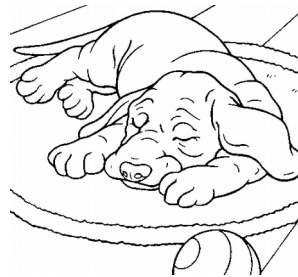

The dog **is** asleep.



My brother **is** an architect



You **am** a student

Complete the following sentences with the verb to be.
Completa las siguientes oraciones con el verbo to be.



My name _____ James.



Mary _____ the secretary



John and Lucy _____ at school.



He _____ a doctor



The boys _____ in the garden

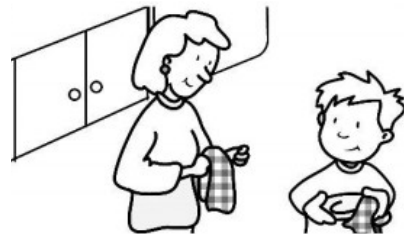

Susie _____ a housewife

Match the figures with the verb to be as applicable.
Une las figuras con el verbo to be segun correspondan.

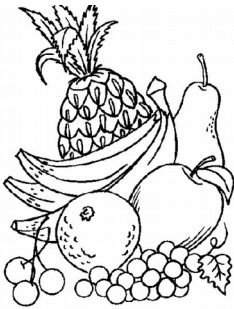

Fruits

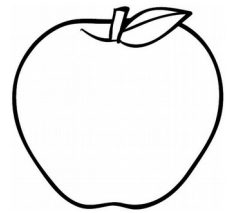

An apple

am



Lion

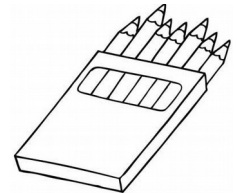

The pencils

is

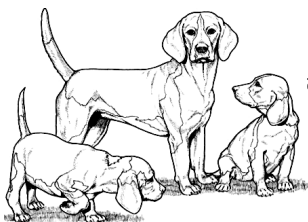

The dogs



Mary and John

are

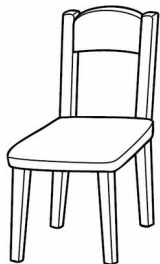

Chair



They friends

¿What time is it?

¿Qué hora es?

Write the time shown on each clock. (Escribe la hora que indica cada reloj)

Examp
e

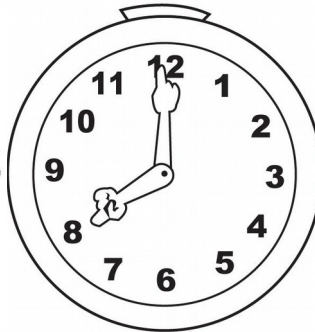

It's eight o'clock



It's _____ o'clock

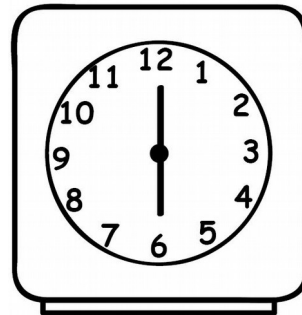

It's _____ o'clock

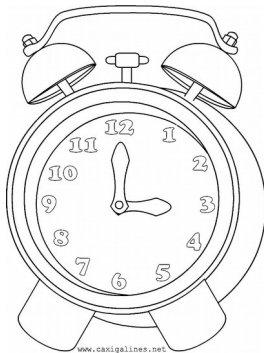

It's _____ o'clock



It's _____ o'clock

Draw. (dibujar)

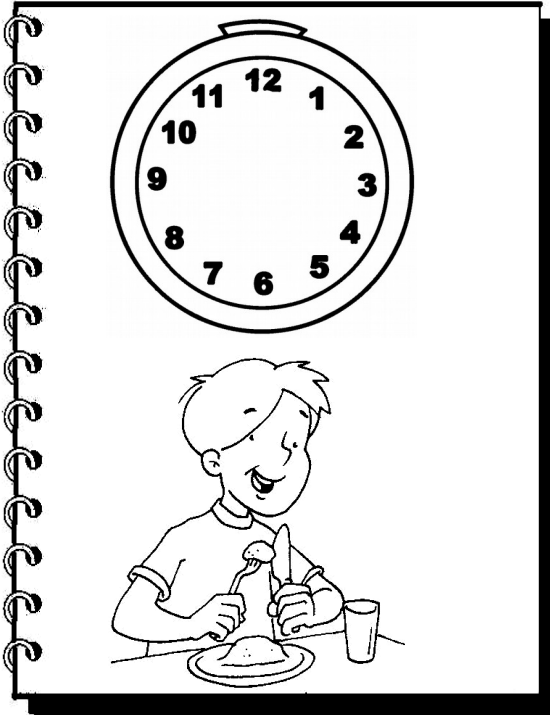

He has lunch at 12: 00



He gets up at 6:30

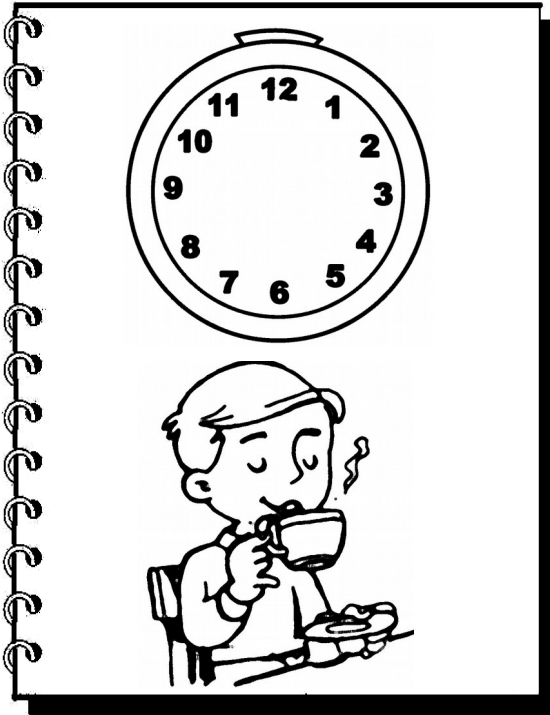

He eats breakfast at 7 o' clock

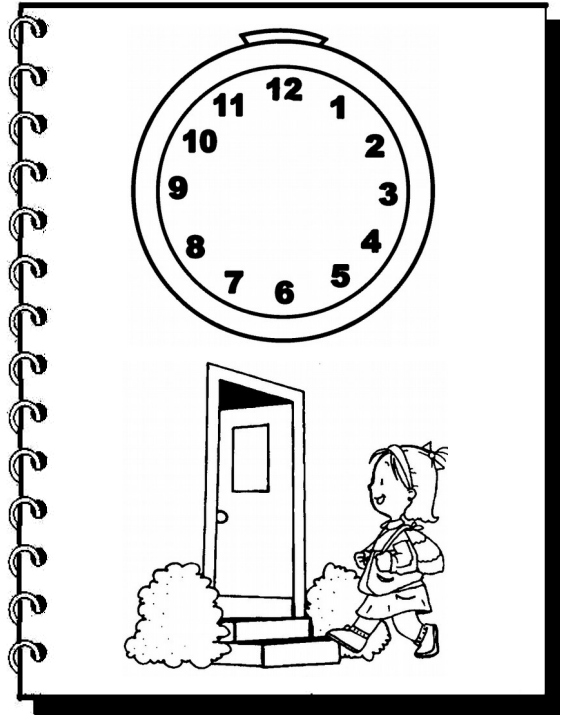

She goes to school at 7:30

THE HOUSE

(de jáus) LA CASA

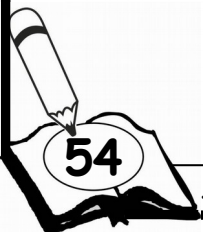

Write in that part of the house is every person.
Escribe en que parte de la casa se encuentra cada persona

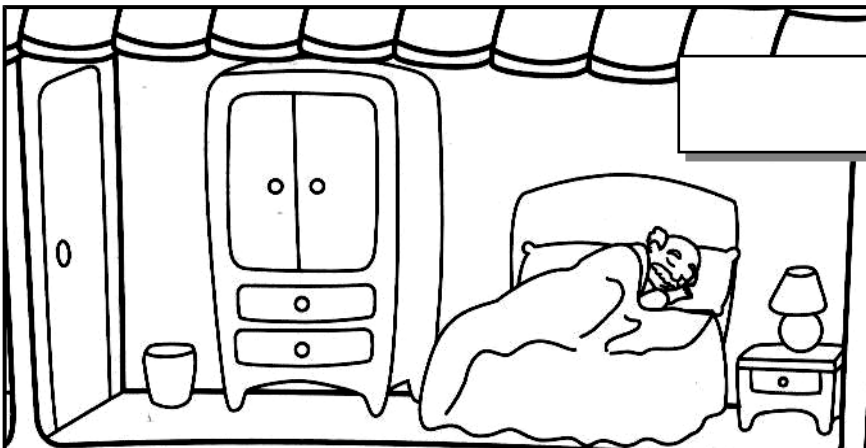
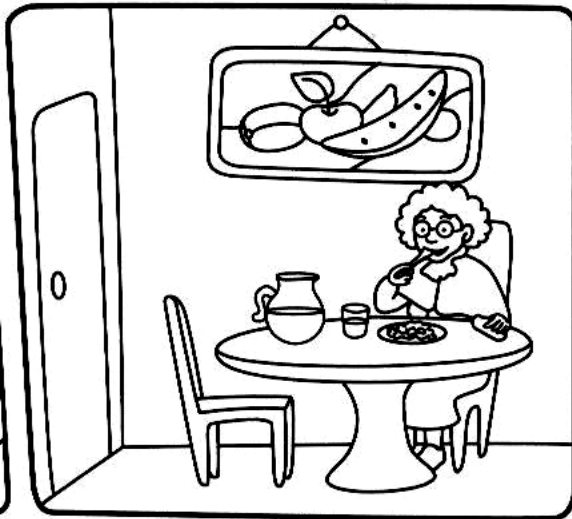
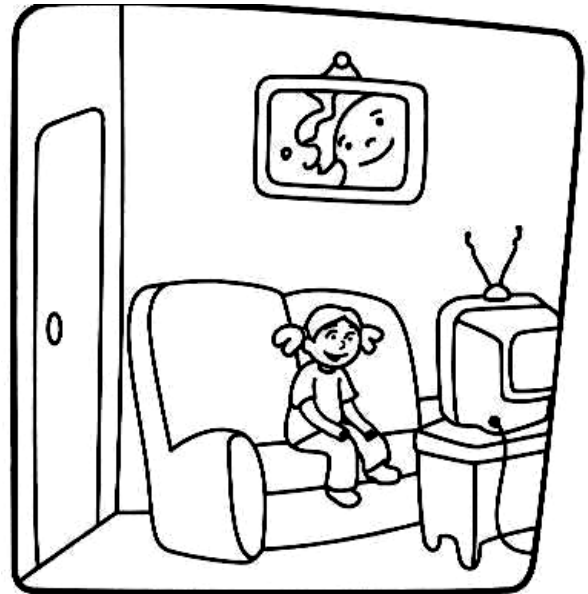

THE HOUSE

(de jáus) LA CASA

VOCABULARY

Español	Ingles	Se lee
Armario	Wardrobe	uadroub
Aseo	Toilet	tóilet
Baño	Bathroom	bázrum
Buzón	Mailbox	méilboks
Cama	Bed	bed
Cocina	Kitchen	kitchin
Comedor	Dining room	dáining rúm
Dormitorio	Bedroom	bédrum
Escaleras	Stairs	sters
Garage	Garage	garedg
Habitación	Room	rúm
Jardín	Garden	gárden
Mesa	Table	teibl
Persianas	Blinds	blains
Alfombra	Carpet	ca:*pet
Balcón	Balcony	bálconi
Botella	Bottle	botl
Caja	Box	boks
Carta	Letter	léta
Cerradura	Lock	lóok
Césped	Grass	gras
Cojín	Cushion	cúsen
Cortina	Curtain	córtin

Español	Ingles	Se lee
Ordenador	Computer	cumpiute
Pared	Wall	uól
Pasillo	Corridor	courida
Piscina	Pool	pul
Piso	Floor	flóor
Puerta	Door	dóor
Salón	Living room	líving rúm
Silla	Chair	che:r
Tejado	Roof	rúf
Terraza	Terrace	téuras
Timbre	Doorbell	dóorbel
Ventana	Window	uíndou
Vestíbulo	Hall	hóol
Lavaplatos	Dishwasher	Dísguose
Felpudo	Doormat	domat
Flor	Flower	flaua
Jabón	Soap	soup
Llave	Key	kíi
Luz	Light	lait
Parte de abajo	Downstairs	daunsters
Parte de arriba	Upstairs	apsters
Picaporte	Door handle	doorhandl
Planta baja	Ground floor	gráund flóor



Unscramble letters and form words. (Ordena las letras y forma palabras)

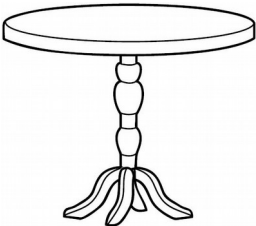

T E
B A L

T

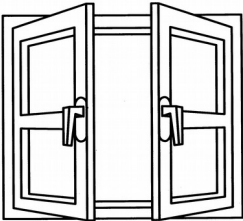

W I
W D
O N

W



I T
C N
K E
H

K

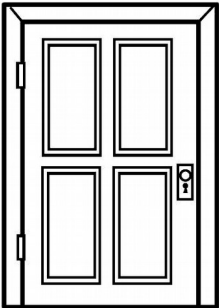

R O
O D

D

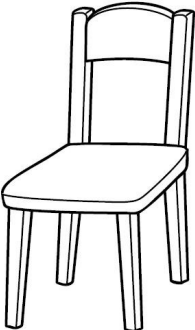

H I
R A
C

C

Complete the following crossword. (Completa el siguiente crucigrama)



BED
STAIRS
BALCONY
CHAIR
POOL
LAMP

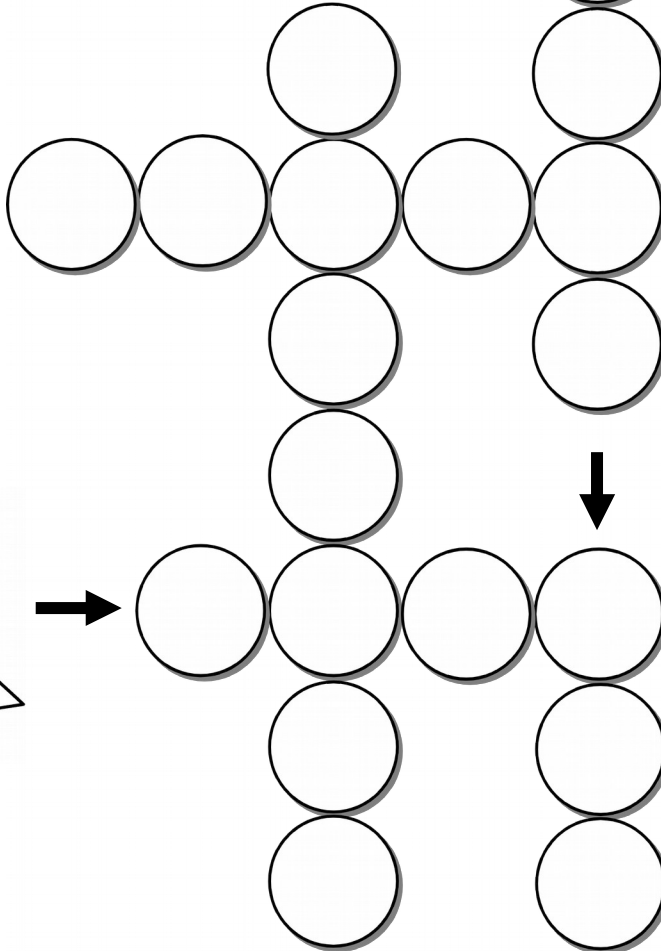
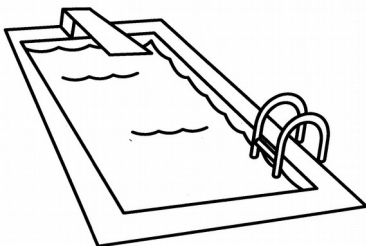
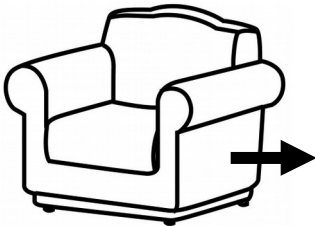
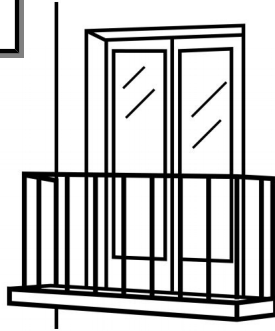
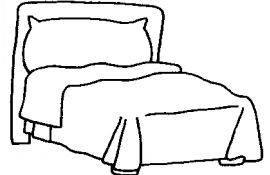
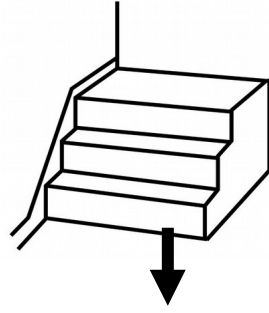

CAN CAN'T PODER

CAN significa poder, ser capaz de, saber (tener capacidad física o conocimiento suficiente para hacer algo).

CAN'T es la forma contracta o reducida de CANNOT (nunca se escribe separado)

Example: You **can** speak English.

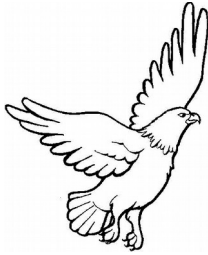

Birds **can** fly

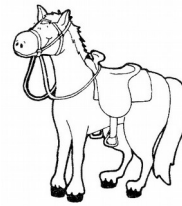

Horses **can't** fly.

Complete the following sentence. (Completa la siguiente oracion)

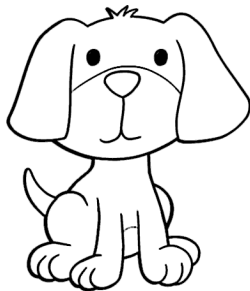

Cookie _____ sing.

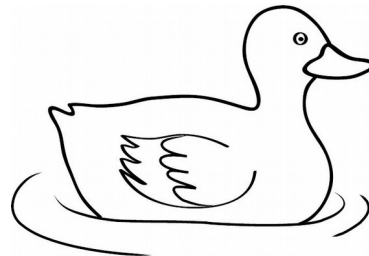

Duck _____ swim.

Answer these questions about yourself. (Conteste estas preguntas acerca de ti)

1. Can you swim? _____
2. Can you fly? _____
3. Can you run fast? _____
4. Can you sing? _____
5. Can you climb trees? _____
6. Can you catch mice? _____

THIS - THESE

ESTE - ESTOS

This = este / esta / esto (singular) **These** = estos / estas (plural)



This flower is beautiful.

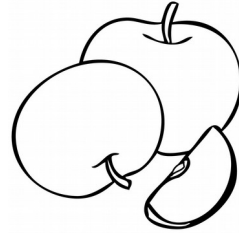

These apples are cheap



_____ house is too big.



_____ flowers are beautiful.

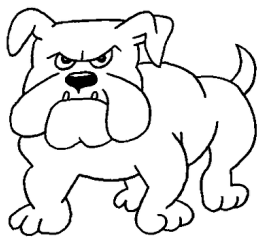

_____ dog is bad.

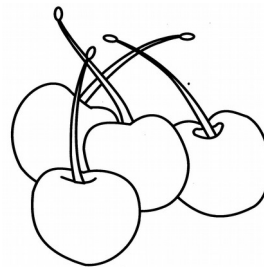

_____ are cherries.

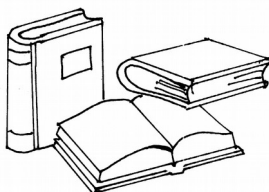

_____ are books.

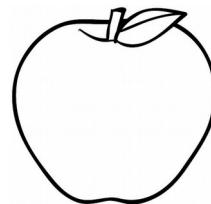

_____ is an apple.

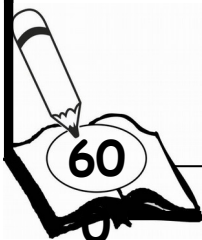

Answer the questions

Responde a las preguntas

Complete the answers to the questions with the words in the box.
Completa las repuestas de las preguntas con las palabras del recuadro.

Eating - Washing Drinking - Looking

1. What's the cat doing?

He's _____ milk.



2. What's he doing?

He's _____ at the mirror.



3. What's he doing?

She's _____ her hands.



4. What's he doing?

He's _____ the apple.



LIKE - DON'T LIKE

GUSTA - NO ME GUSTA

El verbo "like" se conjuga así:

I like + la cosa que quieres (singular o plural)

Los negativos:

I don't like + la cosa que quieres (singular o plural)



Complete the sentences. (Completa las oraciones)

What do you like doing?

I _____ cooking.



I _____ Writing.



I _____ reading.



I _____ painting.



FAST - SLOW

RÁPIDO - LENTO

Write fast or slow as appropriate. (Escribe fast o slow segun corresponda)



It's fast

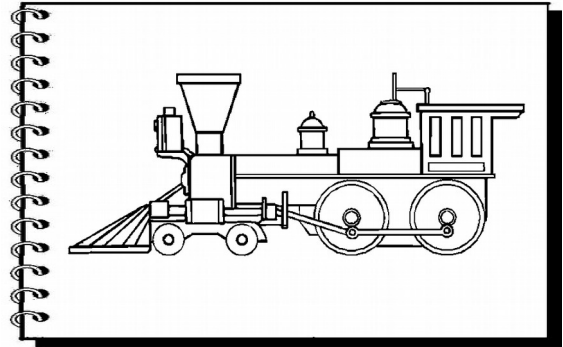

It's _____

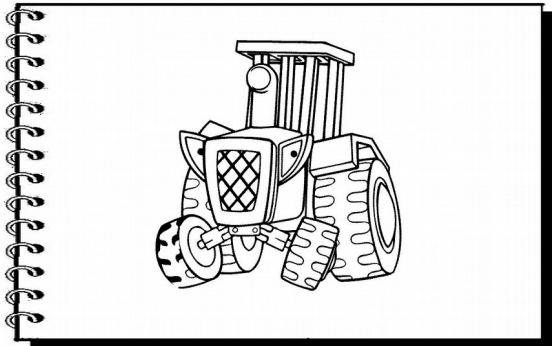

It's _____

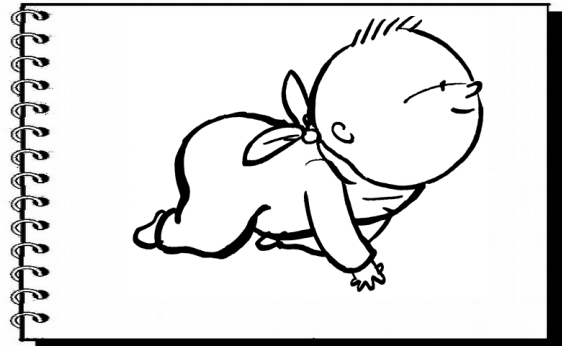

It's _____

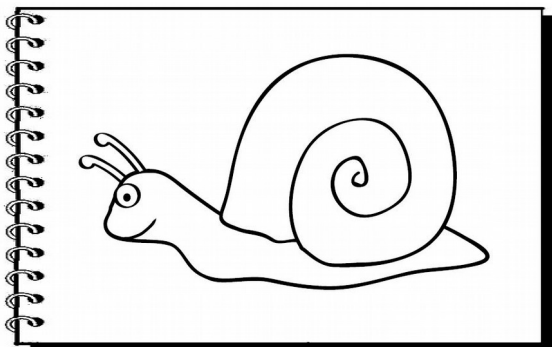

It's _____

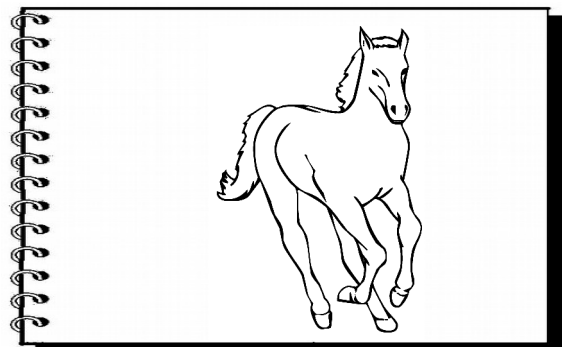

It's _____

SHORT ANSWERS

RESPUESTAS CORTAS

Write. (Escribir)

Yes, he does

No, he doesn't

Yes, she does

No, she doesn't



1 Does Bety play tennis in the morning?



2 Does Mary eat breakfast in the morning?



3 Does John take a shower in the morning?



4 Does Dean sleep in the morning?